











META Washstand fitting with electronic opening and closing function without pop-up waste - Chrome

META

44 511 660



- Infrared sensor technology
- 125mm projection
- height of mixer 140 mm
- height up to aerator 52 mm
- hole diameter 35 mm
- fixed spout
- max. flow 5.7 l/min
- circular, air-enriched flow
- suitable for thermal disinfection
- Automatic shut-off after pre-set time is reached
- Direct temperature control at faucet
- Plug-in power supply included
- lead-free
- 2x screw-in M 8 x 1 pressure hose, leak-tested
- This product can help a building meet the requirements of Green Building Rating Systems, e.g. LEED®, BREEAM®, DGNB

| | | |
|---|--------------------------------|---------------|
|  | Chrome | 44 511 660-00 |
|  | Brushed Platinum | 44 511 660-06 |
|  | Platinum | 44 511 660-08 |
|  | Dark Chrome | 44 511 660-19 |
|  | Light Gold | 44 511 660-26 |
|  | Brushed Light Gold | 44 511 660-27 |
|  | Brushed Durabronze (23kt Gold) | 44 511 660-28 |
|  | Matte Black | 44 511 660-33 |
|  | Brushed Bronze | 44 511 660-42 |
|  | Brushed Champagne (22kt Gold) | 44 511 660-46 |
|  | Champagne (22kt Gold) | 44 511 660-47 |
|  | Brushed Chrome | 44 511 660-93 |
|  | Brushed Dark Platinum | 44 511 660-99 |

44 511 660

mm [inches]

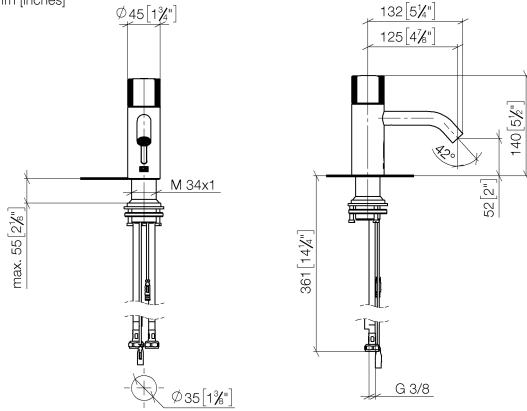

Flow rate chart



Certificates

LGA_38243.

WRAS_2212021.

44 511 660

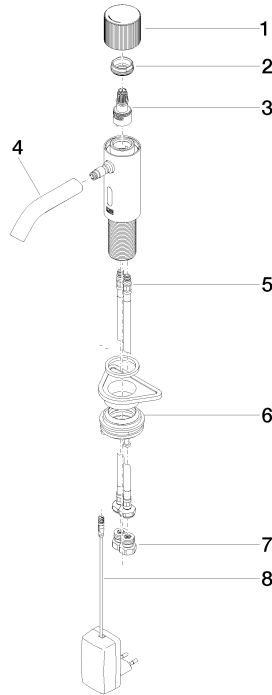

Spare parts list

| No. | Item Number | Name | Quantity used | Delivery time |
|-----|--------------------|--------------|---------------|---------------|
| 1 | 90 20 66 124 00-00 | handle | 1 | 10 |
| 2 | 09 24 04 562 90 | nut | 1 | 60 |
| 3 | 90 90 03 173 00 90 | top | 1 | 2 |
| 4 | 90 11 06 206 00-00 | spout | 1 | 10 |
| 5 | 04 30 04 100 00 90 | hose | 2 | 2 |
| 6 | 04 23 10 044 08 90 | fixing set | 1 | 2 |
| 7 | 90 24 03 314 00 90 | nipple set | 2 | 2 |
| 8 | 90 10 01 251 00 90 | power supply | 1 | 2 |